

# KMA-2400-5

## 2.4–2.5 GHz Omnidirectional Kinetic Mesh® Antenna

The 2.4–2.5 GHz omnidirectional Kinetic Mesh antenna consists of a linear array, encapsulated in a heavy duty fiberglass radome with a thick walled mounting base for reliable long term use. The rugged design allows the antenna to withstand harsh environments and is ideal for industrial and military wireless applications. The antenna is DC grounded for ESD protection of radio components.

### KMA-2400-5 Benefits

- 5 dBi gain
- Type N (male or female) connector
- Fully sealed IP67 (6: Dust-tight, 7: Waterproof) design
- UV stable, black fiberglass radome 0.64" (16.3 mm) diameter
- Black chrome plated mounting base
- DC grounded design



| Technical Data           |                                                                      |
|--------------------------|----------------------------------------------------------------------|
| <b>Maximum Power</b>     | 250 Watt                                                             |
| <b>Nominal Impedance</b> | 50 Ohm                                                               |
| <b>VSWR</b>              | < 1.5:1                                                              |
| <b>Radome Material</b>   | Pultruded fiberglass                                                 |
| <b>ESD Protection</b>    | DC grounded                                                          |
| <b>Rated Wind</b>        | 150 mph (241 km/h)                                                   |
| <b>Connector</b>         | Type N (male or female)                                              |
| <b>Mounting Hardware</b> | 07-100003-001/BAM1013 included with the Type N male connector option |

### RF/Electrical Specifications

| Rajant Part Number | Model         | Frequency Range | Nominal Gain | Return Loss | E-Plane Beamwidth | Connector Type |
|--------------------|---------------|-----------------|--------------|-------------|-------------------|----------------|
| 75-100139-024      | KMA-2400-5-NM | 2.4–2.5 GHz     | 5 dBi        | > 14 dB     | 30°               | N male         |
| 75-100140-024      | KMA-2400-5-NF | 2.4–2.5 GHz     | 5 dBi        | > 14 dB     | 30°               | N female       |

### Mechanical Specifications

| Rajant Part Number | Model         | Weight         | Height            | Rated Wind Load  | Bending Moment at Rated Wind | Equivalent Flat Plate Area                    |
|--------------------|---------------|----------------|-------------------|------------------|------------------------------|-----------------------------------------------|
| 75-100139-024      | KMA-2400-5-NM | 5 oz (141.7 g) | 9.83" (24.97 cm)  | 2.8 lbf (12.5 N) | 1.36 ft-lbf (1.84 Nm)        | 0.036 ft <sup>2</sup> (33.4 cm <sup>2</sup> ) |
| 75-100140-024      | KMA-2400-5-NF | 5 oz (141.7 g) | 10.03" (25.48 cm) | 2.8 lbf (12.5 N) | 1.36 ft-lbf (1.84 Nm)        | 0.036 ft <sup>2</sup> (33.4 cm <sup>2</sup> ) |

**E-Plane  
Radiation  
Pattern**

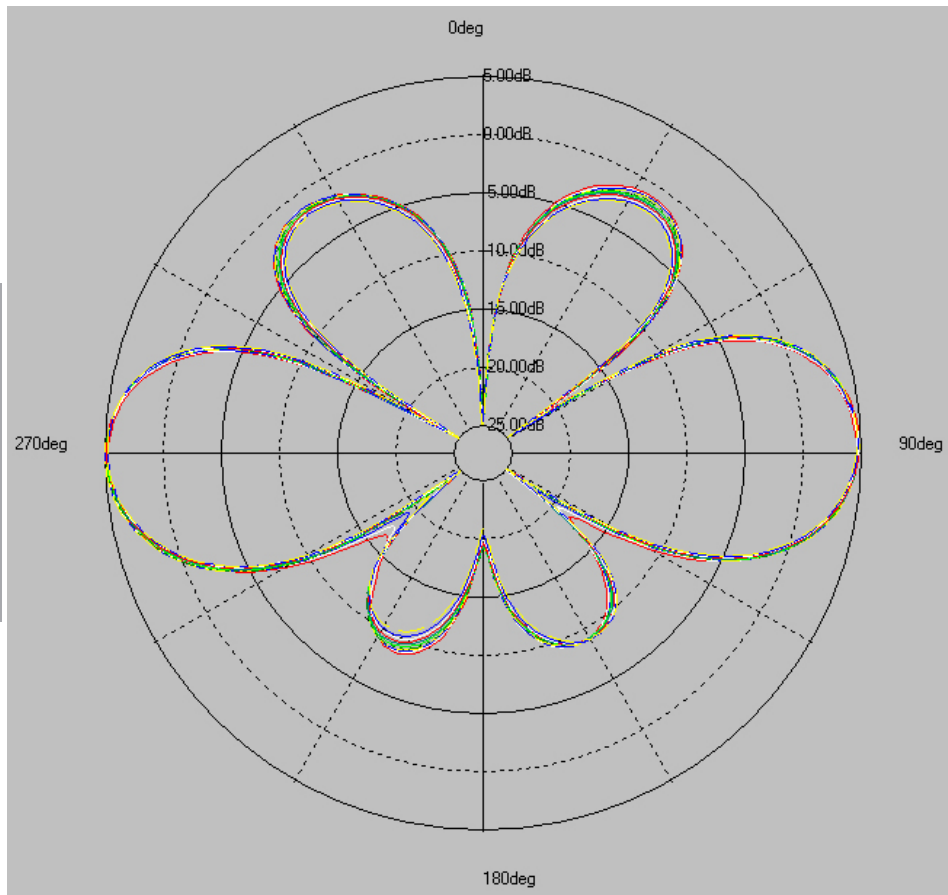
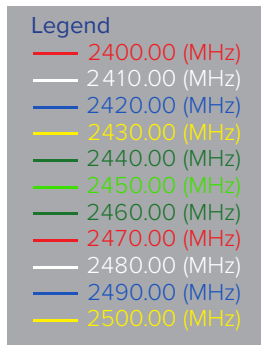

**H-Plane  
Radiation  
Pattern**

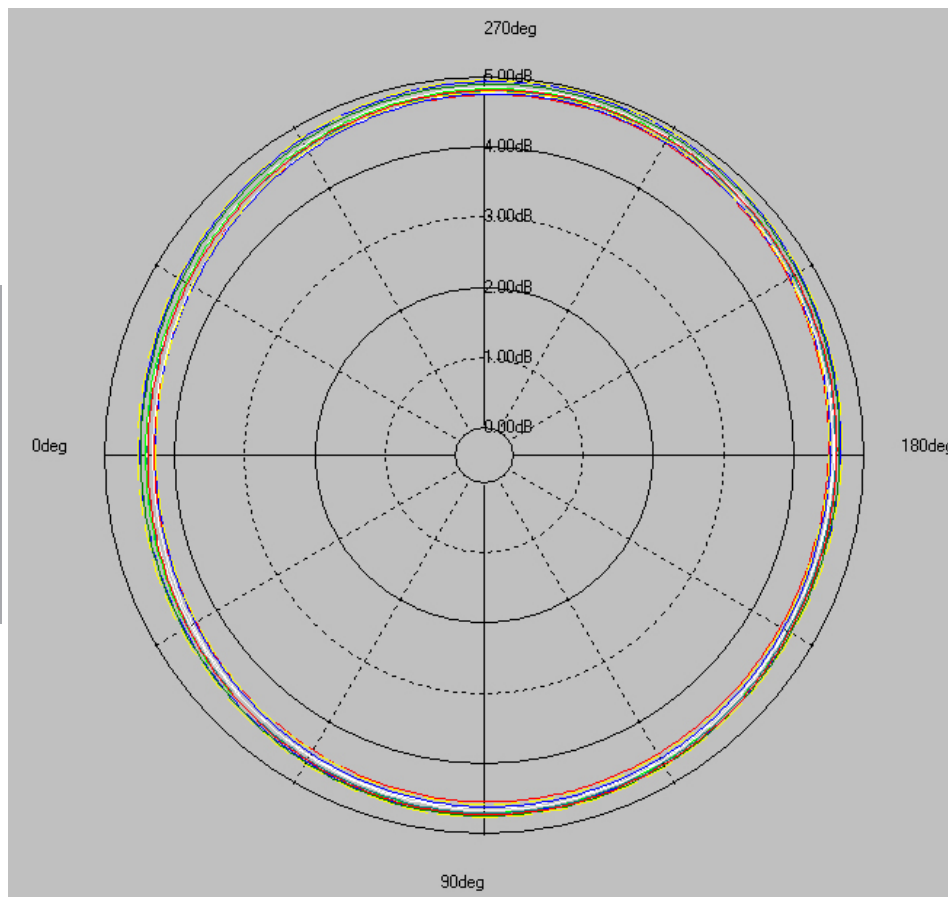
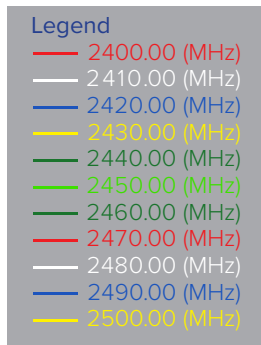

**KMA-2400-5-NM Dimensions**

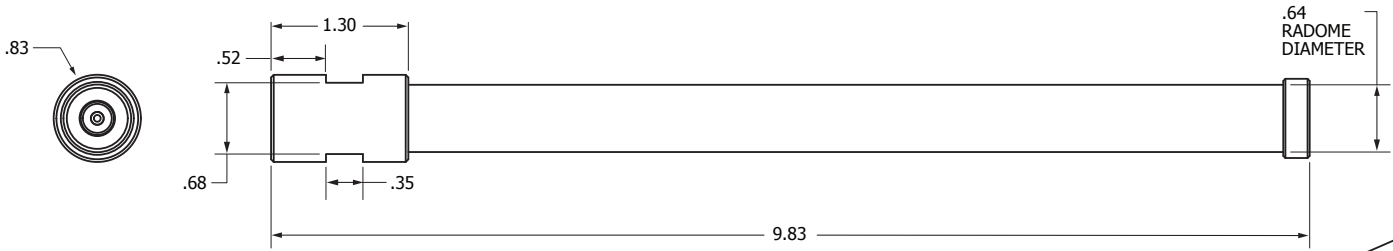

Unless otherwise specified dimensions are in inches.  
1 inch = 2.54 cm

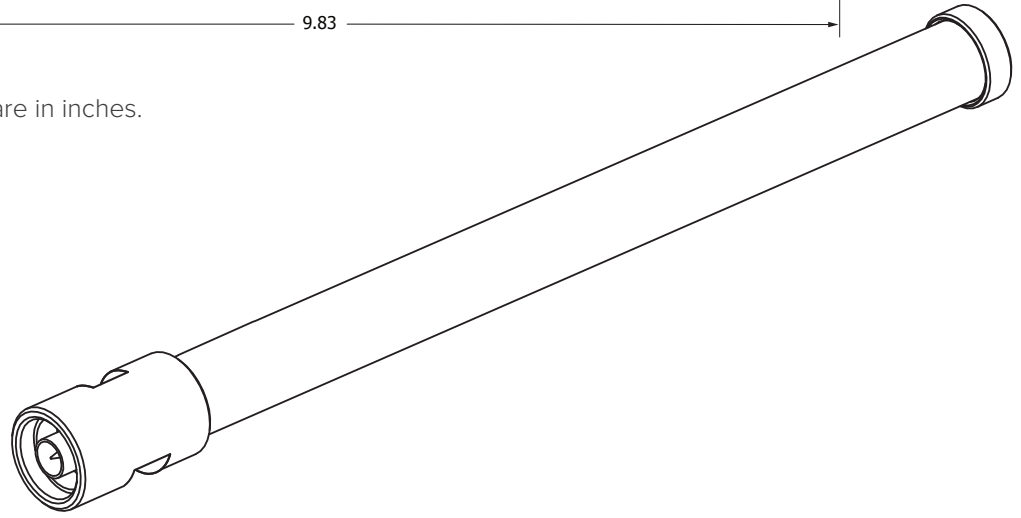

**KMA-2400-5-NF Dimensions**

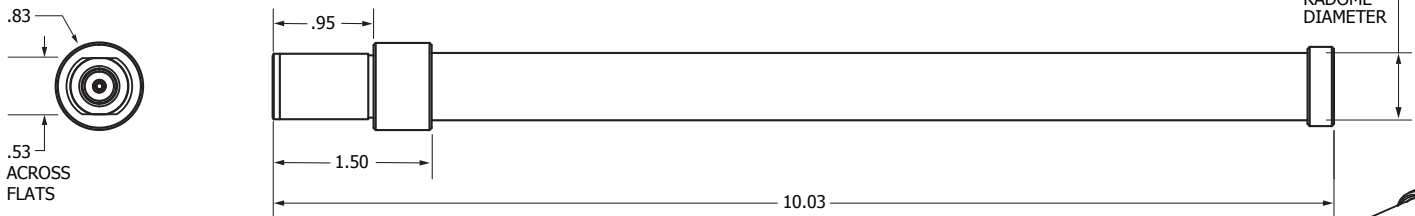

Unless otherwise specified dimensions are in inches.  
1 inch = 2.54 cm

